



GARRETT SPECIALTIES

a promotional product company

eProof

2 Split Rock Drive Suite 11, Cherry Hill, NJ 08003

Telephone: 1-856 424-4818 or 1-800 320-1510

Fax: 1-856 424-5269

Hours of Operation: 9:00 - 5:30 pm Eastern, M - F

Customer Service E-mail: service@garrettspecialties.com

Order#: 130347

Product: Small Snake Puzzle

Item #: 1364-308181

Imprint Method: Screen Print on Panel 1 - Black

Actual Imprint Size: 0.5"W x 0.1"H

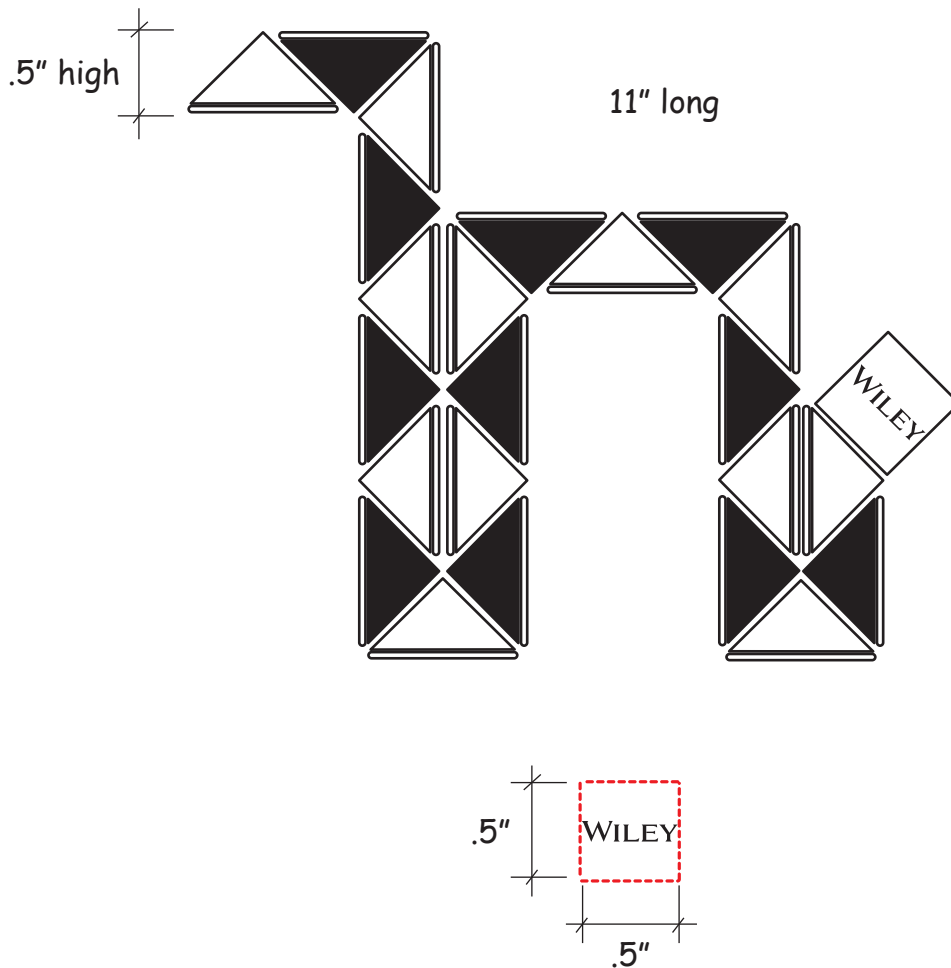

*****IMPORTANT INFORMATION*** (PLEASE READ)**

Please proof carefully for spelling errors, omissions, and layout accuracy. It is your responsibility to correct any errors. Garrett Specialties assumes no responsibility for errors after a proof has been authorized to print. Please note changes or revisions to your proof from your original instructions may cause revision in your ship date. Delays in paper proof approval also may require a change in your schedule ship dates. Occasionally, some fax machines may distort the image. Please pay close attention to numbers.

It is imperative that you view your e-proof and submit your approval and/or changes promptly to maintain your anticipated delivery date.

Please keep in mind that this virtual proof is not a printed sample of your artwork on our product. The size and placement of the artwork may vary from this proof when actually printed on the product. Carefully review the attached proof for verification of copy & layout.

Due to inherent technical differences in color monitors, the imprint colors and product colors depicted in the attached proof will not resemble those in the final product. We make every effort to match requested custom colors, but cannot guarantee a 100% exact match. Imprints are applied using pad or screen inks. These inks are hand mixed as close as possible to the requested color but may vary 2 to 4 shades. For this reason an exact PMS match cannot be guaranteed.

Your order is ON HOLD until we receive an approval from you in reference to your artwork.